

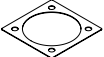







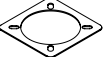

- SE** ELUTTAG FÖR SKÅP OCH HYLLA
- NO** STIKKONTAKT TIL SKAP OG HYLLE
- FI** PISTORASIA KAAPILLE JA HYLLEYLLE
- DK** EL-UDTAG FOR SKAB OG HYLDE
- ENG** SOCKET FOR CABINET AND SHELF

-  X1
-  X1
-  X1
-  X1
-  X8
DIN 7981C St3,5x13
-  X2
DIN 7981C St2,9x8
-  X4
ISO 7089, 4

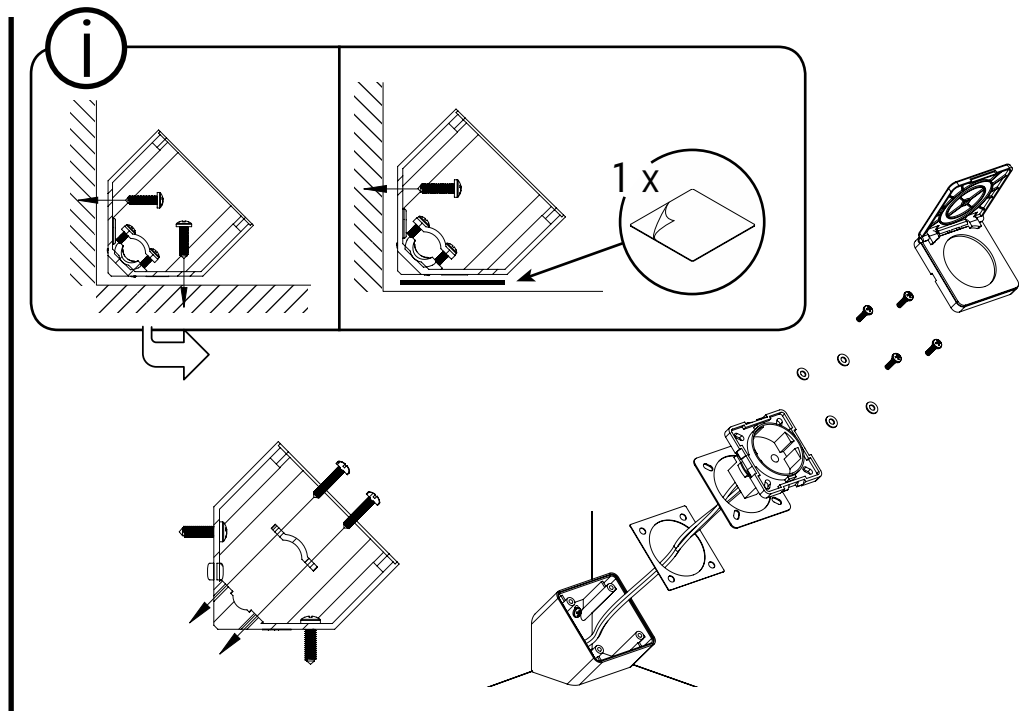

- SE** ELUTTAG FÖR UTDRAGSLÅDA
- NO** STIKKONTAKT TIL SKUFF
- FI** PISTORASIA LAATIKOLLE
- DK** EL-UDTAG FOR SKUFFE
- ENG** SOCKET FOR DRAWER

-  X1
-  X8
DIN 7981C St3,5x13
-  X4
ISO 7089, 4

